

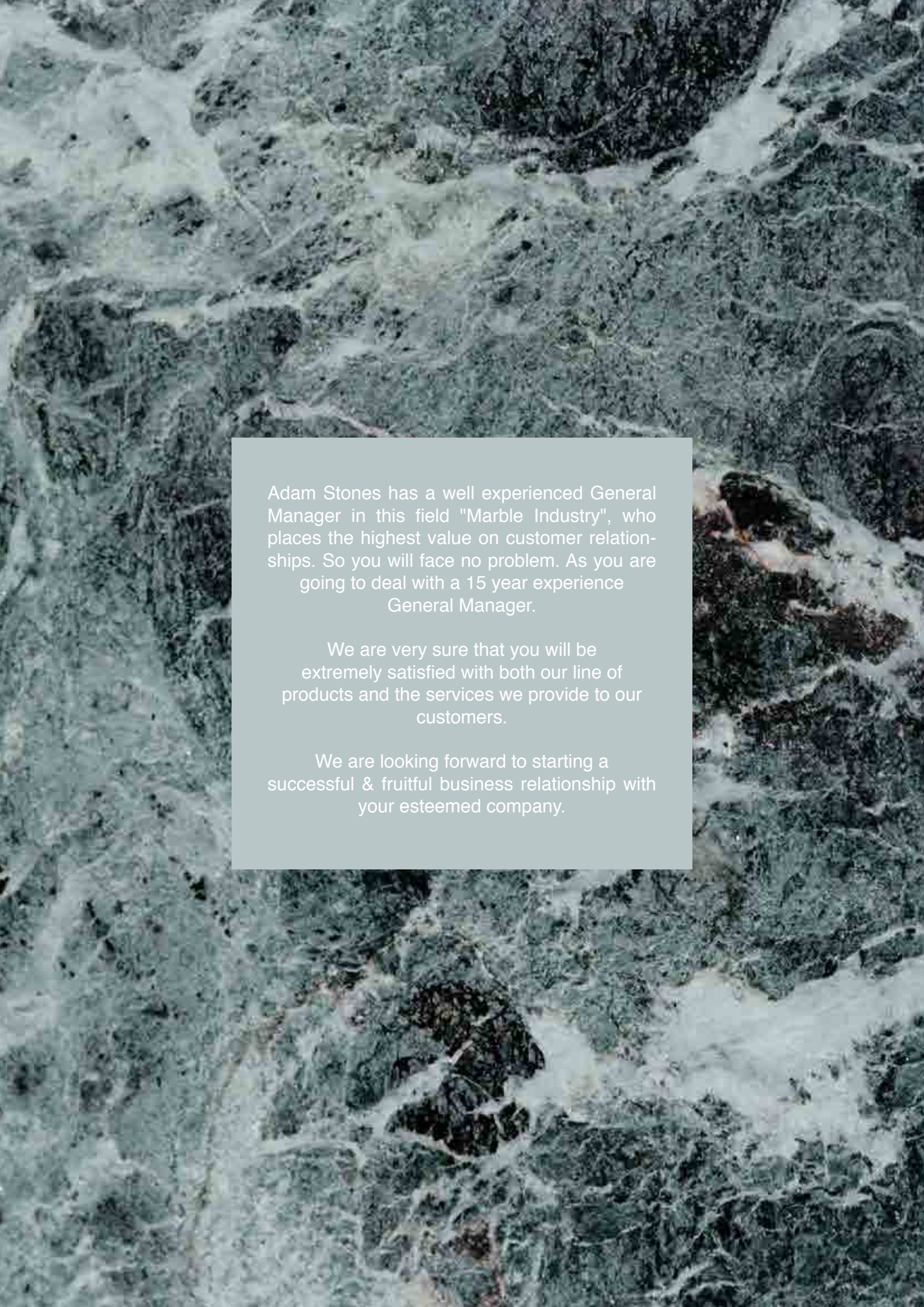

# ADAM STONE

The Natural Stone Company

The Finest Marble patterns  
all over the world



Adam Stones has a well experienced General Manager in this field "Marble Industry", who places the highest value on customer relationships. So you will face no problem. As you are going to deal with a 15 year experience General Manager.

We are very sure that you will be extremely satisfied with both our line of products and the services we provide to our customers.

We are looking forward to starting a successful & fruitful business relationship with your esteemed company.



# Content

About US	02
Marble Products	04
Granite	17
Mosaics	19
Finishing Methods	27
Installation Ideas	28
Projects	29
Packing & Export	34

# About Us



## Adam Stones "Quarry Owner & Exporter"

It's a great pride for us to contact your gorgeous Firm's staff. Adam Stones Co is a leading Supplier & distributor of the finest Marble patterns all over the world.

Our products are characterized by their High Quality; they are processed using high technology.

Our marble products cover tiles, slabs and all sizes as well as the styles are available for your customized design. As for finishes, we face no trouble in meeting your decorative requirements such as Unpolished, Polished, Honed, Bush Hummerd, flamed, Antique Acide, Brushed and others.

Customer's satisfaction is our motto; Adam Stone's staff is able to supply you with your needs before delivery time.

We look forward to providing you with your touch of elegance with Egyptian Marble & Granite.

# Company Profile



We are one of the well known companies working in the field of Marble, Granite and Stones in Egypt. We are dealing in exporting the Egyptian stones since 2001 and we are exporting to 30 countries all over Europe , Asia and North America.

Our Stones Are Well Known all over the the World and our Materials are beige, Brown or yellow in color .And we have Supplied our Materials to many projects residential and commercial.

And we are owners of 8 quarries which allows us to go through. huge orders as we apply a very strict quality control and selection .

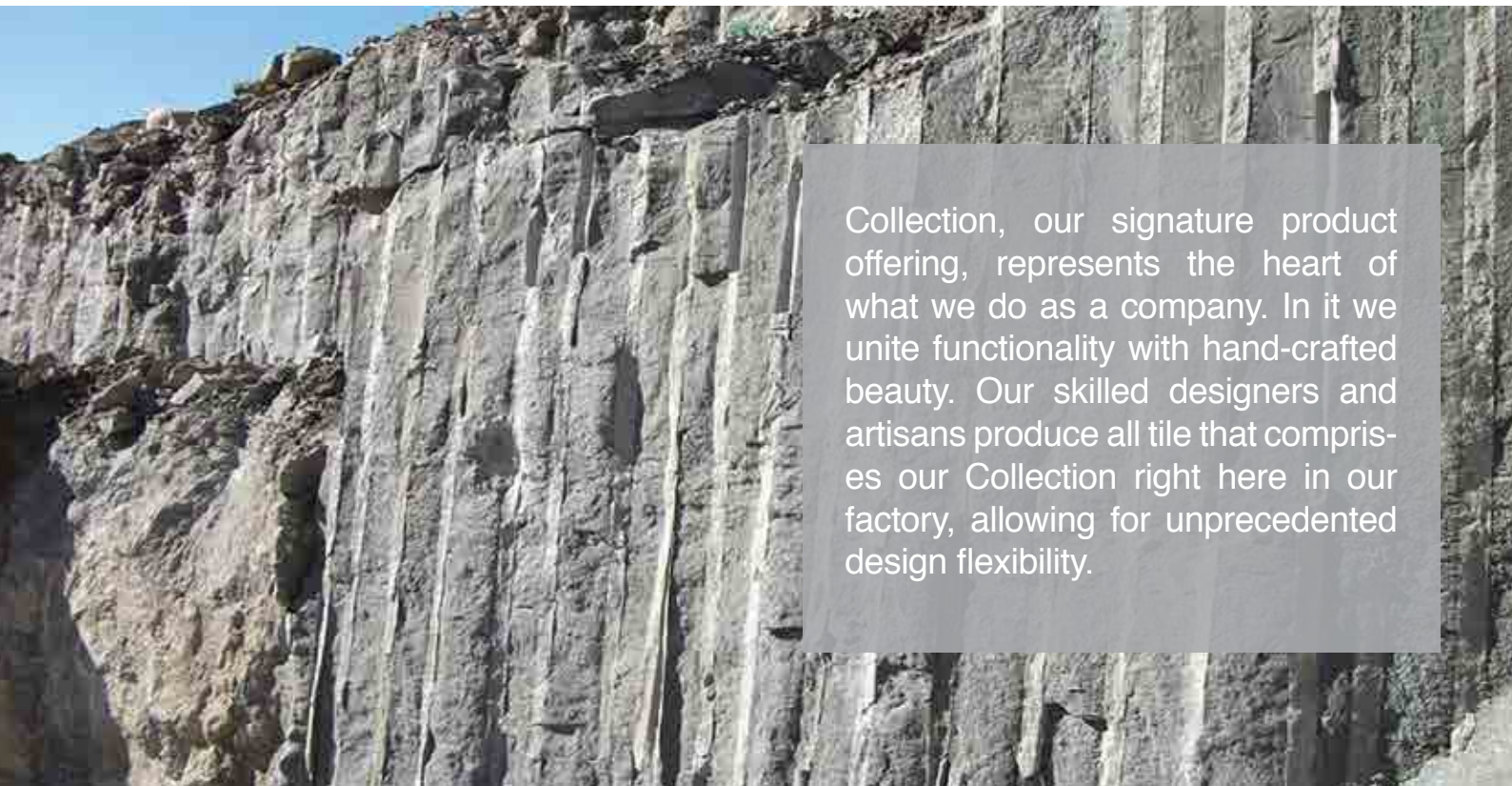

Collection, our signature product offering, represents the heart of what we do as a company. In it we unite functionality with hand-crafted beauty. Our skilled designers and artisans produce all tile that comprises our Collection right here in our factory, allowing for unprecedented design flexibility.

# Marble Products



Combining function with beauty, tile is the ideal way to bring art into any environment. Created from simple materials, tile has captured every movement in design, color and form throughout history. Yet, regardless of what form it takes, it always conveys a deep sense of emotion wherever it is used. Tile brings a space to life because it is a personal expression of those who live there.





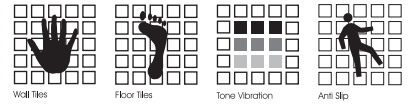

# Marble Products

# Galala

## ASTM Standards

ASTM Standards	Results
- Abrasion resistance Hardness [ ASTM C241/ C1353]	34.8 Ha
- Flexural Strength MPA. [AST M C 880]	1300 Psi
- Modules Of Rupture MPA. [AST M C99]	1800 Psi
- Compressive Strength MPA. [AST M C170]	18300 Psi
- Absorption by Weight [AST C97]	%0.12
- Bulk Specific Gravity	2627

GL-E 004



GL-R 003

GL-Y 006



GL-E 001   GL-E 003   GL-Y 002   GL-T 004   GL-C 005   GL-Y 007

## Roman Pattern

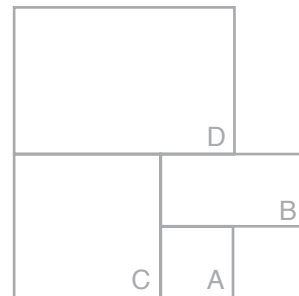

- A- 8" x 8" x 1/2" (20cm x 20cm x 1.2cm)
- B- 8" x 16" x 1/2" (20cm x 40.6cm x 1.2cm)
- C- 16" x 16" x 1/2" (40.6cm x 40.6cm x 1.2cm)
- D- 16" x 24" x 1/2" (40.6cm x 61cm x 1.2cm)

## Galala I Code GL

Sizes:

Roman Pattern: A, B, C, D

Plain Tiles: E, F, G, H

Small Tiles: I, J, K, L

Slabs: M, N

Finishes:

P, H, B, T, AW, SB, PB, BH

## Plain Tiles

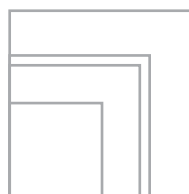

- E- 12" x 12" x 3/8" (30.5cm x 30.5cm x 1cm)
- F- 16" x 16" x 1/2" (40.6cm x 40.6cm x 1.2cm)
- G- 18" x 18" x 1/2" (45.7cm x 45.7cm x 1.2cm)
- H- 24" x 24" x 5/8" (61cm x 61cm x 1.5cm)

## Small Tiles



- I- 4" x 4" x 3/8" (10cm x 10cm x 1cm)
- J- 6" x 6" x 3/8" (15cm x 15cm x 1cm)
- K- 6" x 3" x 3/8" (15cm x 7.5cm x 1cm)
- L- 8" x 8" x 3/8" (20cm x 20cm x 1cm)

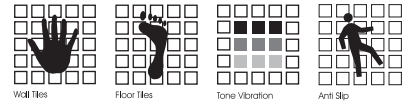

# Marble Products

## Sunny

### ASTM Standards

ASTM Standards	Results
- Abrasion resistance Hardness [ ASTM C241/ C1353]	26.4 Ha
- Flexural Strength MPA. [AST M C 880]	1600 Psi
- Modules Of Rupture MPA. [AST M C99]	2000 Psi
- Compressive Strength MPA. [AST M C170]	13300 Psi
- Absorption by Weight [AST C97]	%0.30
- Bulk Specific Gravity	2618

SU-Y 002



SU-C 007 SU-C 008 SU-C 009



SU-C 001 SU-C 003 SU-C 004 SU-C 005 SU-C 006

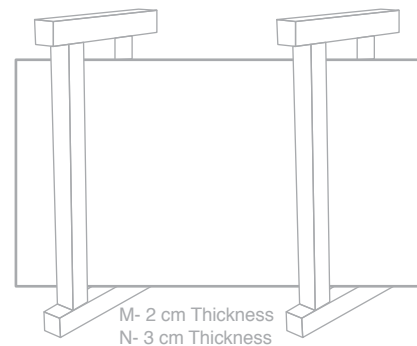

SLABS

### Sunny I Code SU

Sizes:

Roman Pattern: A, B, C, D

Plain Tiles: E, F, G, H

Small Tiles: I, J, K, L

Slabs: M, N

Finishes:

P, H, B, T, AW, SB, PB, BH

### Finishes

P	Polished
H	Honed
HCE	Honed and chiseled Edge
B	Brushed
BCE	Brushed and chiseled Edge
T	Tumbled
AW	Acid Washed
SB	Sand Blasted
PB	Poly Brushed
BH	Bush Hammer
FL	Flamed



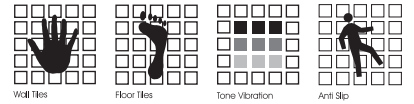

# Marble Products

## New Sunny

### ASTM Standards

ASTM Standards	Results
- Abrasion resistance Hardness [ ASTM C241/ C1353]	26.4 Ha
- Flexural Strength MPA. [AST M C 880]	1600 Psi
- Modules Of Rupture MPA. [AST M C99]	2000 Psi
- Compressive Strength MPA. [AST M C170]	13300 Psi
- Absorption by Weight [AST C97]	%0.30
- Bulk Specific Gravity	2618

SU-Y 002



SU-C 001      SU-C 003      SU-C 004      SU-C 005

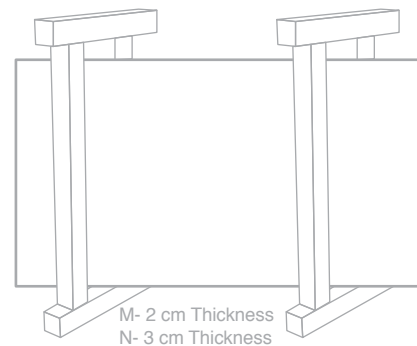

SLABS

### Sunny I Code SU

Sizes:

Roman Pattern: A, B, C, D

Plain Tiles: E, F, G, H

Small Tiles: I, J, K, L

Slabs: M, N

Finishes:

P, H, B, T, AW, SB, PB, BH

### Finishes

P	Polished
H	Honed
HCE	Honed and chiseled Edge
B	Brushed
BCE	Brushed and chiseled Edge
T	Tumbled
AW	Acid Washed
SB	Sand Blasted
PB	Poly Brushed
BH	Bush Hammer
FL	Flamed

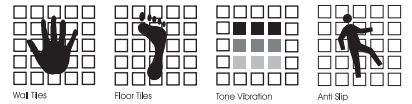

# Marble Products

# New Silvia

## ASTM Standards

ASTM Standards	Results
- Abrasion resistance Hardness [ ASTM C241/ C1353]	26.7 Ha
- Flexural Strength MPA. [AST M C 880]	1000 Psi
- Modules Of Rupture MPA. [AST M C99]	1400 Psi
- Compressive Strength MPA. [AST M C170]	10400 Psi
- Absorption by Weight [AST C97]	%1.62
- Bulk Specific Gravity	2478

SY 001



SY 002

SY 003

SY 004

SY 005

## Roman Pattern

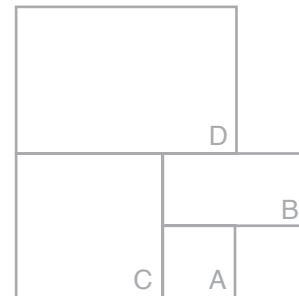

- A- 8" x 8" x 1/2" (20cm x 20cm x 1.2cm)
- B- 8" x 16" x 1/2" (20cm x 40.6cm x 1.2cm)
- C- 16" x 16" x 1/2" (40.6cm x 40.6cm x 1.2cm)
- D- 16" x 24" x 1/2" (40.6cm x 61cm x 1.2cm)

## Sylvia I Code SY

Sizes:

Roman Pattern: A, B, C, D

Plain Tiles: E, F, G, H

Small Tiles: I, J, K, L

Slabs: M, N

Finishes:

P, H, B, T, AW, SB, PB, BH

## Plain Tiles

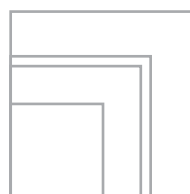

- E- 12" x 12" x 3/8" (30.5cm x 30.5cm x 1cm)
- F- 16" x 16" x 1/2" (40.6cm x 40.6cm x 1.2cm)
- G- 18" x 18" x 1/2" (45.7cm x 45.7cm x 1.2cm)
- H- 24" x 24" x 5/8" (61cm x 61cm x 1.5cm)

## Small Tiles



- I- 4" x 4" x 3/8" (10cm x 10cm x 1cm)
- J- 6" x 6" x 3/8" (15cm x 15cm x 1cm)
- K- 6" x 3" x 3/8" (15cm x 7.5cm x 1cm)
- L- 8" x 8" x 3/8" (20cm x 20cm x 1cm)

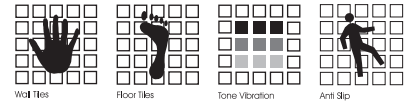

# Marble Products

# Sinai Pearl

## ASTM Standards

ASTM Standards	Results
- Abrasion resistance Hardness [ ASTM C241/ C1353]	31.6 Ha
- Flexural Strength MPA. [AST M C 880]	1200 Psi
- Modules Of Rupture MPA. [AST M C99]	1700 Psi
- Compressive Strength MPA. [AST M C170]	16700 Psi
- Absorption by Weight [AST C97]	%0.17
- Bulk Specific Gravity	2675

FL 001



## Roman Pattern

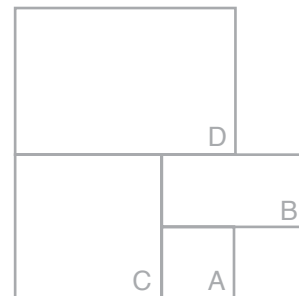

- A- 8" x 8" x 1/2" (20cm x 20cm x 1.2cm)
- B- 8" x 16" x 1/2" (20cm x 40.6cm x 1.2cm)
- C- 16" x 16" x 1/2" (40.6cm x 40.6cm x 1.2cm)
- D- 16" x 24" x 1/2" (40.6cm x 61cm x 1.2cm)



FL 002      FL 003      FL 004      FL 005

## Flito I Code FL

Sizes:

Roman Pattern: A, B, C, D

Plain Tiles: E, F, G, H

Small Tiles: I, J, K, L

Slabs: M, N

Finishes:

P, H, B, T, AW, SB, PB, BH

## Plain Tiles

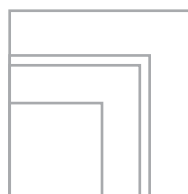

- E- 12" x 12" x 3/8" (30.5cm x 30.5cm x 1cm)
- F- 16" x 16" x 1/2" (40.6cm x 40.6cm x 1.2cm)
- G- 18" x 18" x 1/2" (45.7cm x 45.7cm x 1.2cm)
- H- 24" x 24" x 5/8" (61cm x 61cm x 1.5cm)

## Small Tiles



- I- 4" x 4" x 3/8" (10cm x 10cm x 1cm)
- J- 6" x 6" x 3/8" (15cm x 15cm x 1cm)
- K- 6" x 3" x 3/8" (15cm x 7.5cm x 1cm)
- L- 8" x 8" x 3/8" (20cm x 20cm x 1cm)



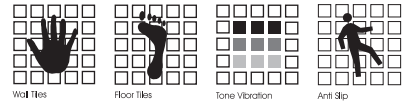

# Marble Products

## Flito

### ASTM Standards

ASTM Standards	Results
- Abrasion resistance Hardness [ ASTM C241/ C1353]	31.6 Ha
- Flexural Strength MPA. [AST M C 880]	1200 Psi
- Modules Of Rupture MPA. [AST M C99]	1700 Psi
- Compressive Strength MPA. [AST M C170]	16700 Psi
- Absorption by Weight [AST C97]	%0.17
- Bulk Specific Gravity	2675

FL 001



### Roman Pattern

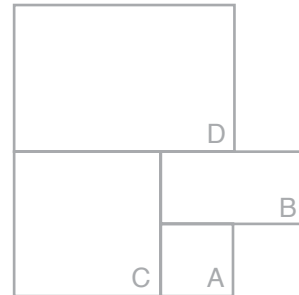

- A- 8" x 8" x 1/2" (20cm x 20cm x 1.2cm)
- B- 8" x 16" x 1/2" (20cm x 40.6cm x 1.2cm)
- C- 16" x 16" x 1/2" (40.6cm x 40.6cm x 1.2cm)
- D- 16" x 24" x 1/2" (40.6cm x 61cm x 1.2cm)



FL 002



FL 003



FL 004



FL 005



FL 006

### Flito I Code FL

Sizes:

Roman Pattern: A, B, C, D

Plain Tiles: E, F, G, H

Small Tiles: I, J, K, L

Slabs: M, N

Finishes:

P, H, B, T, AW, SB, PB, BH

### Plain Tiles

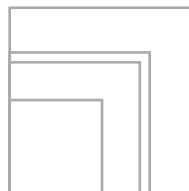

- E- 12" x 12" x 3/8" (30.5cm x 30.5cm x 1cm)
- F- 16" x 16" x 1/2" (40.6cm x 40.6cm x 1.2cm)
- G- 18" x 18" x 1/2" (45.7cm x 45.7cm x 1.2cm)
- H- 24" x 24" x 5/8" (61cm x 61cm x 1.5cm)

### Small Tiles



- I- 4" x 4" x 3/8" (10cm x 10cm x 1cm)
- J- 6" x 6" x 3/8" (15cm x 15cm x 1cm)
- K- 6" x 3" x 3/8" (15cm x 7.5cm x 1cm)
- L- 8" x 8" x 3/8" (20cm x 20cm x 1cm)

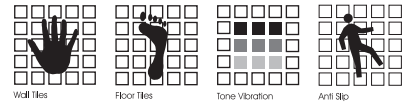

# Marble Products

# Pearl Yellow

## ASTM Standards

ASTM Standards	Results
- Abrasion resistance Hardness [ ASTM C241/ C1353]	26.4 Ha
- Flexural Strength MPA. [AST M C 880]	1600 Psi
- Modules Of Rupture MPA. [AST M C99]	2000 Psi
- Compressive Strength MPA. [AST M C170]	13300 Psi
- Absorption by Weight [AST C97]	%0.30
- Bulk Specific Gravity	2618

SU-Y 002



SU-C 001

SU-C 003

SU-C 004

SU-C 005

## Sunny I Code SU

Sizes:

Roman Pattern: A, B, C, D

Plain Tiles: E, F, G, H

Small Tiles: I, J, K, L

Slabs: M, N

Finishes:

P, H, B, T, AW, SB, PB, BH

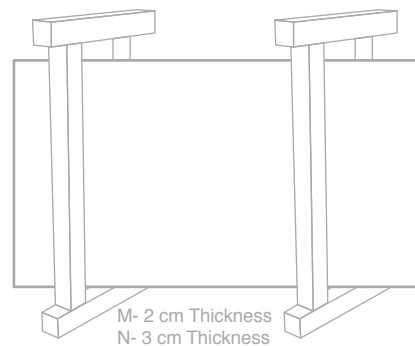

SLABS

## Finishes

P	Polished
H	Honed
HCE	Honed and chiseled Edge
B	Brushed
BCE	Brushed and chiseled Edge
T	Tumbled
AW	Acid Washed
SB	Sand Blasted
PB	Poly Brushed
BH	Bush Hummer
FL	Flamed

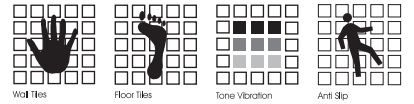

# Marble Products

## Silvia

### ASTM Standards

ASTM Standards	Results
- Abrasion resistance Hardness [ ASTM C241/ C1353]	26.7 Ha
- Flexural Strength MPA. [AST M C 880]	1000 Psi
- Modules Of Rupture MPA. [AST M C99]	1400 Psi
- Compressive Strength MPA. [AST M C170]	10400 Psi
- Absorption by Weight [AST C97]	%1.62
- Bulk Specific Gravity	2478

SY 001

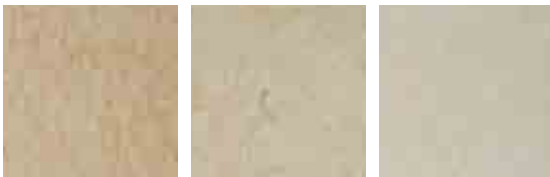

SY 002

SY 003

SY 004

### Roman Pattern

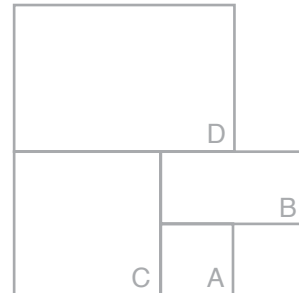

- A- 8" x 8" x 1/2" (20cm x 20cm x 1.2cm)
- B- 8" x 16" x 1/2" (20cm x 40.6cm x 1.2cm)
- C- 16" x 16" x 1/2" (40.6cm x 40.6cm x 1.2cm)
- D- 16" x 24" x 1/2" (40.6cm x 61cm x 1.2cm)

### Sylvia I Code SY

Sizes:

Roman Pattern: A, B, C, D

Plain Tiles: E, F, G, H

Small Tiles: I, J, K, L

Slabs: M, N

Finishes:

P, H, B, T, AW, SB, PB, BH

### Plain Tiles

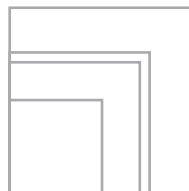

- E- 12" x 12" x 3/8" (30.5cm x 30.5cm x 1cm)
- F- 16" x 16" x 1/2" (40.6cm x 40.6cm x 1.2cm)
- G- 18" x 18" x 1/2" (45.7cm x 45.7cm x 1.2cm)
- H- 24" x 24" x 5/8" (61cm x 61cm x 1.5cm)

### Small Tiles



- I- 4" x 4" x 3/8" (10cm x 10cm x 1cm)
- J- 6" x 6" x 3/8" (15cm x 15cm x 1cm)
- K- 6" x 3" x 3/8" (15cm x 7.5cm x 1cm)
- L- 8" x 8" x 3/8" (20cm x 20cm x 1cm)



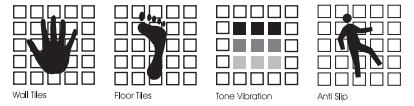

# Marble Products

# Catrina

## ASTM Standards

ASTM Standards	Results
- Abrasion resistance Hardness [ ASTM C241/ C1353]	26.4 Ha
- Flexural Strength MPA. [AST M C 880]	1600 Psi
- Modules Of Rupture MPA. [AST M C99]	2000 Psi
- Compressive Strength MPA. [AST M C170]	13300 Psi
- Absorption by Weight [AST C97]	%0.30
- Bulk Specific Gravity	2618

SU-Y 002



SU-C 001    SU-C 003    SU-C 004    SU-C 005    SU-C 006

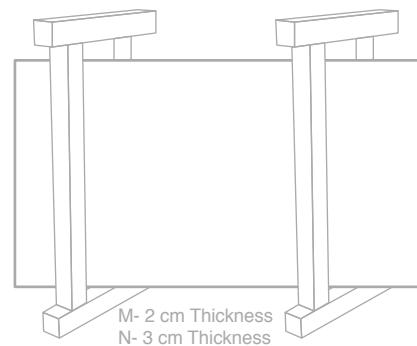

SLABS

## Catrina I Code SU

Sizes:

Roman Pattern: A, B, C, D

Plain Tiles: E, F, G, H

Small Tiles: I, J, K, L

Slabs: M, N

Finishes:

P, H, B, T, AW, SB, PB, BH

## Finishes

P	Polished
H	Honed
HCE	Honed and chiseled Edge
B	Brushed
BCE	Brushed and chiseled Edge
T	Tumbled
AW	Acid Washed
SB	Sand Blasted
PB	Poly Brushed
BH	Bush Hummer
FL	Flamed

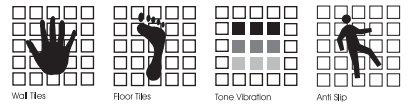

# Marble Products

# Milly Brown

## ASTM Standards

ASTM Standards	Results
- Abrasion resistance Hardness [ ASTM C241/ C1353]	26.7 Ha
- Flexural Strength MPA. [AST M C 880]	1000 Psi
- Modules Of Rupture MPA. [AST M C99]	1400 Psi
- Compressive Strength MPA. [AST M C170]	10400 Psi
- Absorption by Weight [AST C97]	%1.62
- Bulk Specific Gravity	2478

SY 001



SY 002

SY 003

SY 004

SY 005

## Roman Pattern

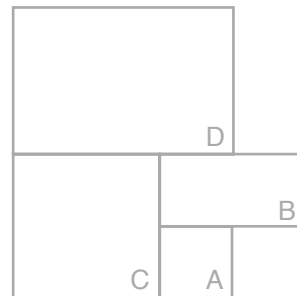

- A- 8" x 8" x 1/2" (20cm x 20cm x 1.2cm)
- B- 8" x 16" x 1/2" (20cm x 40.6cm x 1.2cm)
- C- 16" x 16" x 1/2" (40.6cm x 40.6cm x 1.2cm)
- D- 16" x 24" x 1/2" (40.6cm x 61cm x 1.2cm)

## Sylvia I Code SY

Sizes:

Roman Pattern: A, B, C, D

Plain Tiles: E, F, G, H

Small Tiles: I, J, K, L

Slabs: M, N

Finishes:

P, H, B, T, AW, SB, PB, BH

## Plain Tiles

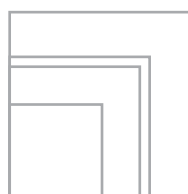

- E- 12" x 12" x 3/8" (30.5cm x 30.5cm x 1cm)
- F- 16" x 16" x 1/2" (40.6cm x 40.6cm x 1.2cm)
- G- 18" x 18" x 1/2" (45.7cm x 45.7cm x 1.2cm)
- H- 24" x 24" x 5/8" (61cm x 61cm x 1.5cm)

## Small Tiles



- I- 4" x 4" x 3/8" (10cm x 10cm x 1cm)
- J- 6" x 6" x 3/8" (15cm x 15cm x 1cm)
- K- 6" x 3" x 3/8" (15cm x 7.5cm x 1cm)
- L- 8" x 8" x 3/8" (20cm x 20cm x 1cm)

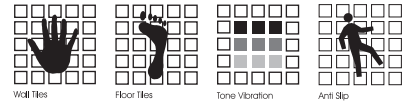

# Marble Products

# Milly Grey

## ASTM Standards

ASTM Standards	Results
- Abrasion resistance Hardness [ ASTM C241/ C1353]	26.4 Ha
- Flexural Strength MPA. [AST M C 880]	1600 Psi
- Modules Of Rupture MPA. [AST M C99]	2000 Psi
- Compressive Strength MPA. [AST M C170]	13300 Psi
- Absorption by Weight [AST C97]	%0.30
- Bulk Specific Gravity	2618

SU-Y 002



SU-C 001    SU-C 003    SU-C 004    SU-C 005

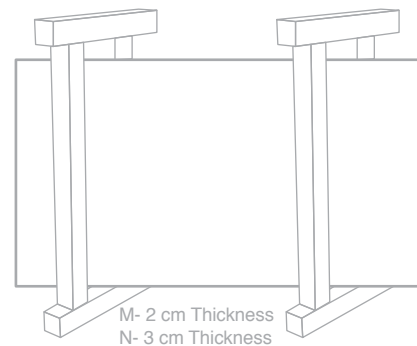

SLABS

## Sunny I Code SU

Sizes:

Roman Pattern: A, B, C, D

Plain Tiles: E, F, G, H

Small Tiles: I, J, K, L

Slabs: M, N

Finishes:

P, H, B, T, AW, SB, PB, BH

## Finishes

P	Polished
H	Honed
HCE	Honed and chiseled Edge
B	Brushed
BCE	Brushed and chiseled Edge
T	Tumbled
AW	Acid Washed
SB	Sand Blasted
PB	Poly Brushed
BH	Bush Hammer
FL	Flamed



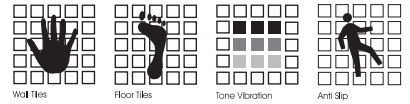

# Marble Products

# Zafarana

## ASTM Standards

ASTM Standards	Results
- Abrasion resistance Hardness [ ASTM C241/ C1353]	26.7 Ha
- Flexural Strength MPA. [AST M C 880]	1000 Psi
- Modules Of Rupture MPA. [AST M C99]	1400 Psi
- Compressive Strength MPA. [AST M C170]	10400 Psi
- Absorption by Weight [AST C97]	%1.62
- Bulk Specific Gravity	2478

SY 001



## Roman Pattern

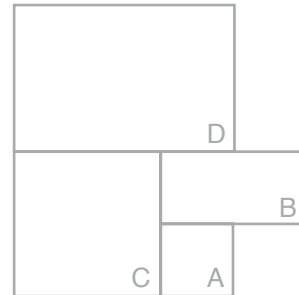

- A- 8" x 8" x 1/2" (20cm x 20cm x 1.2cm)
- B- 8" x 16" x 1/2" (20cm x 40.6cm x 1.2cm)
- C- 16" x 16" x 1/2" (40.6cm x 40.6cm x 1.2cm)
- D- 16" x 24" x 1/2" (40.6cm x 61cm x 1.2cm)



SY 002 SY 003 SY 004

## Sylvia I Code SY

Sizes:

Roman Pattern: A, B, C, D

Plain Tiles: E, F, G, H

Small Tiles: I, J, K, L

Slabs: M, N

Finishes:

P, H, B, T, AW, SB, PB, BH

## Plain Tiles

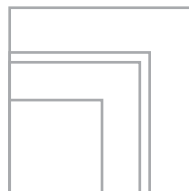

- E- 12" x 12" x 3/8" (30.5cm x 30.5cm x 1cm)
- F- 16" x 16" x 1/2" (40.6cm x 40.6cm x 1.2cm)
- G- 18" x 18" x 1/2" (45.7cm x 45.7cm x 1.2cm)
- H- 24" x 24" x 5/8" (61cm x 61cm x 1.5cm)

## Small Tiles



- I- 4" x 4" x 3/8" (10cm x 10cm x 1cm)
- J- 6" x 6" x 3/8" (15cm x 15cm x 1cm)
- K- 6" x 3" x 3/8" (15cm x 7.5cm x 1cm)
- L- 8" x 8" x 3/8" (20cm x 20cm x 1cm)



# Marble Products

# Golden Sinai

## ASTM Standards

ASTM Standards	Results
- Abrasion resistance Hardness [ ASTM C241/ C1353]	26.5 Ha
- Flexural Strength MPA. [AST M C 880]	1400 Psi
- Modules Of Rupture MPA. [AST M C99]	1600 Psi
- Compressive Strength MPA. [AST M C170]	15600 Psi
- Absorption by Weight [AST C97]	%1.31
- Bulk Specific Gravity	2567

GS 001



GS 006



GS 007



GS 002



GS 003



GS 004



GS 005

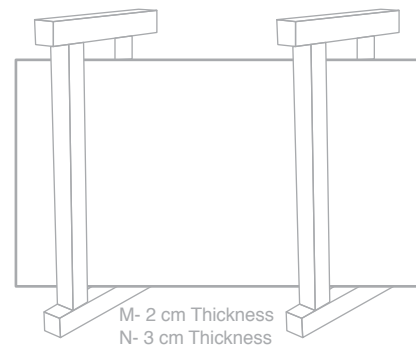

SLABS

## Golden Sinai I Code GS

Sizes:

Roman Pattern: A, B, C, D

Plain Tiles: E, F, G, H

Small Tiles: I, J, K, L

Slabs: M, N

Finishes:

P, H, B, T, AW, SB, PB, BH

## Finishes

P	Polished
H	Honed
HCE	Honed and chiseled Edge
B	Brushed
BCE	Brushed and chiseled Edge
T	Tumbled
AW	Acid Washed
SB	Sand Blasted
PB	Poly Brushed
BH	Bush Hammer
FL	Flamed



# Marble Products

# Egy Emprador

## ASTM Standards

ASTM Standards	Results
- Abrasion resistance Hardness [ ASTM C241/ C1353]	29.8 Ha
- Flexural Strength MPA. [AST M C 880]	1400 Psi
- Modules Of Rupture MPA. [AST M C99]	1800 Psi
- Compressive Strength MPA. [AST M C170]	12600 Psi
- Absorption by Weight [AST C97]	%0.12
- Bulk Specific Gravity	2581

EM 001



EM 002

EM 003

EM 004

EM 005

EM 006

## Emprado I Code EM

Sizes:

Roman Pattern: No

Plain Tiles: E, F, G, H

Small Tiles: I, J, K, L

Slabs: M, N

Finishes:

P, H, B, T, AW, SB, PB, BH

## Plain Tiles

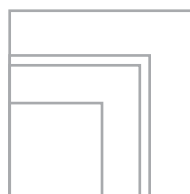

E- 12" x 12" x 3/4" (30.5cm x 30.5cm x 2cm)

F- 16" x 16" x 3/4" (40.6cm x 40.6cm x 2cm)

G- 18" x 18" x 3/4" (45.7cm x 45.7cm x 2cm)

H- 24" x 24" x 3/4" (61cm x 61cm x 2cm)

## Small Tiles



I- 4" x 4" x 3/8" (10cm x 10cm x 1cm)

J- 6" x 6" x 3/8" (15cm x 15cm x 1cm)

K- 6" x 3" x 3/8" (15cm x 7.5cm x 1cm)

L- 8" x 8" x 3/8" (20cm x 20cm x 1cm)

# Granite



A natural material sourced from all over the world, stone meticulously records the passage of time and plays it back to us through a visual diary of stunning color and texture. An unparalleled medium for interior spaces, our use of stone today reflects an appreciation for the dignity of natural materials. Our programmatic approach to the category allows the flexibility to create your ideal environment from floor to ceiling.



# Granite Products

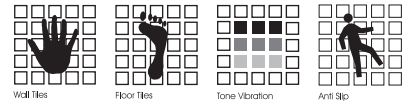

## Aswan Black

Sizes:  
 Roman Pattern: A, B, C, D  
 Plain Tiles: E, F, G, H  
 Small Tiles: I, J, K, L  
 Slabs: M, N

Finishes:  
 P



## White Halayeb

Sizes:  
 Roman Pattern: A, B, C, D  
 Plain Tiles: E, F, G, H  
 Small Tiles: I, J, K, L  
 Slabs: M, N

Finishes:  
 P



## Aswan Red

Sizes:  
 Roman Pattern: A, B, C, D  
 Plain Tiles: E, F, G, H  
 Small Tiles: I, J, K, L  
 Slabs: M, N

Finishes:  
 P



## Rose Royal

Sizes:  
 Roman Pattern: A, B, C, D  
 Plain Tiles: E, F, G, H  
 Small Tiles: I, J, K, L  
 Slabs: M, N

Finishes:  
 P

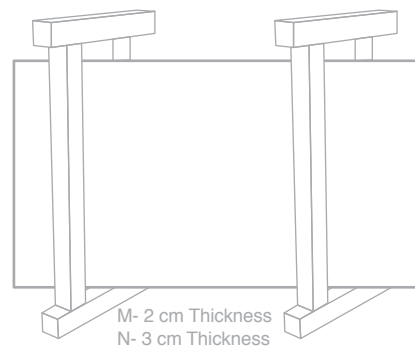

SLABS

## Finishes

P	Polished
H	Honed
HCE	Honed and chiseled Edge
B	Brushed
BCE	Brushed and chiseled Edge
T	Tumbled
AW	Acid Washed
SB	Sand Blasted
PB	Poly Brushed
BH	Bush Hammer
FL	Flamed



# Mosaics

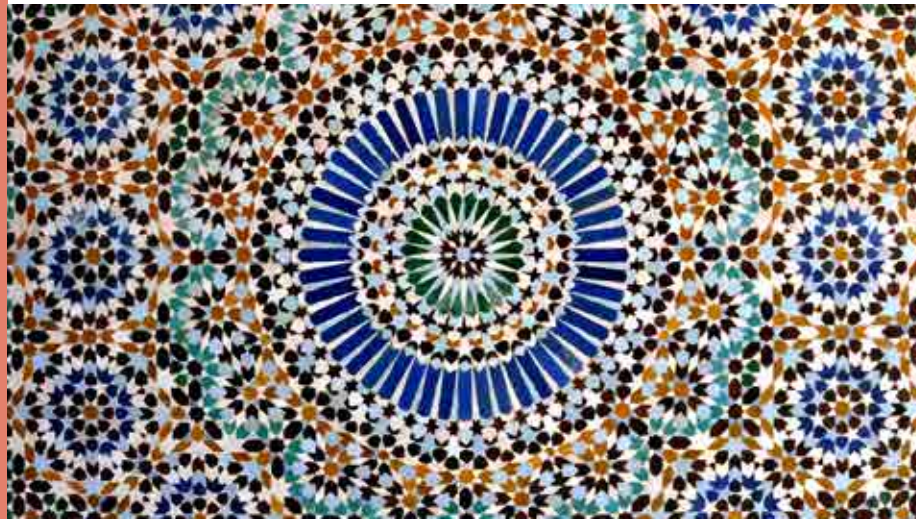

This ancient art form offers infinite design options limited only by one's imagination. The myriad colors, patterns and materials can be combined to create works of art that enhance any environment, from traditional to modern.





# Mosaics

These material in different figures:

Rough blocks - Unpolished slabs - polished slabs  
 Tiles - Brushed - Antiques - Cut to Size, Various  
 dimension as well as calibrated and beveled tiles  
 and special size.



Medallion

Diego



Fiera



Celtic



Derma



Raa



Sottoriva



Gideon



Arena



Finca



Horus

# Mosaics

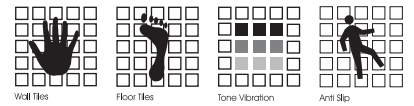

T2E-008T

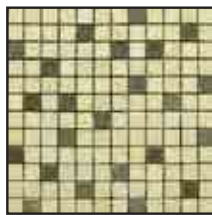

T001GM-P

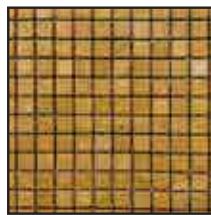

T001Y-TW

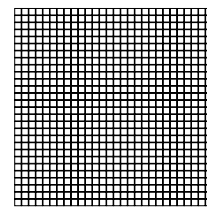

Size: 3/8" x 3/8" (1cm x 1cm)  
Sheet Size: 11.7/8" x 11.7/8"  
(30.2cm x 30.2cm)



T001G-H



TDO12Y



TDO12SYT

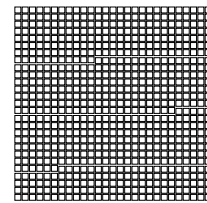

Size: 3/8" x 3/8" (1cm x 1cm)  
Sheet Size: 11.7/8" x 11.7/8"  
(30.2cm x 30.2cm)



T007GT-H



R-GYM

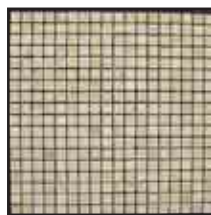

T011G-H

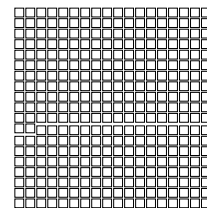

Size: 5/8" x 5/8" (1.5cm x 1.5cm)  
Sheet Size: 12" x 12"  
(30.5cm x 30.5cm)



TDO12T

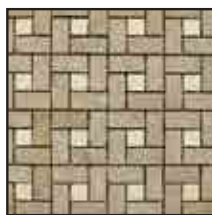

T007TG-H



SP-F

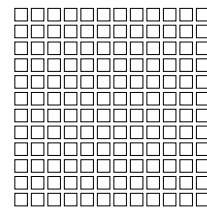

Size: 3/4" x 3/4" (2cm x 2cm)  
Sheet Size: 12" x 12"  
(30.5cm x 30.5cm)

# Mosaics



T010GT-H



T011K-P



R-S

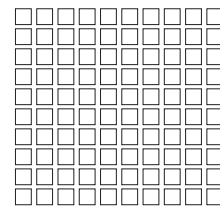

Size: 1" x 1" (2.5cm x 2.5cm)  
Sheet Size: 11.7/8" x 11.7/8"  
(30.2cm x 30.2cm)

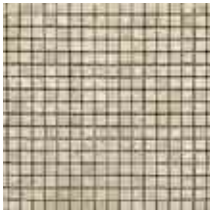

T011T-H



R-GK

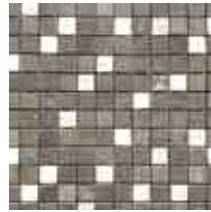

T001MC-H

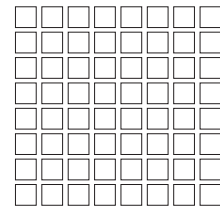

Size: 1.1/8" x 1.1/8" (3cm x 3cm)  
Sheet Size: 11.3/8" x 11.3/8"  
(28.8cm x 28.8cm)

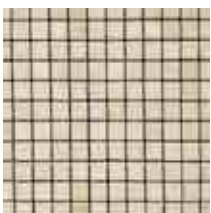

T001G-T

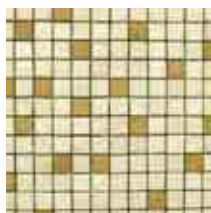

TOO1GY-T



T-008T

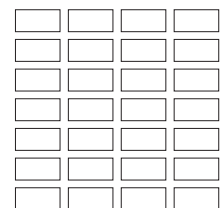

Size: 1.1/4" x 2.5" (3.2cm x 6.5cm)  
Sheet Size: 11.5/8" x 11.7/8"  
(29.7cm x 30.2cm)



T003G-T



TOO4K-TW

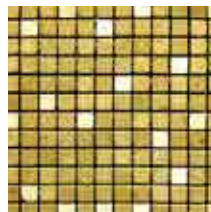

TOO1YG-T

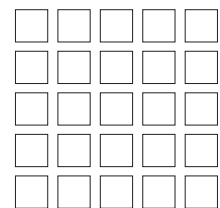

Size: 2" x 2" (5cm x 5cm)  
Sheet Size: 11.7/8" x 11.7/8"  
(30.2cm x 30.2cm)



# Mosaics

# Wall Panels



Wallpanel-1-GG



Code: P-001G  
Dimension: 4 CM\*30 CM  
Material: GALALA HONED



Code: WP-1-G  
Dimension: 90 CM\*30C M  
Material: GALALA HONED AND THE ENGRAVING IS GOLD PAINTED



Code: P-002G  
Dimension: 10 CM\*30 CM  
Material: GALALA HONED



Wallpanel-3-T



Code: P-001T  
Dimension: 4 CM\*30 CM  
Material: TRIESTA HONED



Code: B-TOO-4T  
Dimension: 10 CM\*30 CM  
Material: TRIESTA HONED



Code: B-TOO-4T  
Dimension: 10 CM\*30 CM  
Material: TRIESTA HONED



Code: WP-3-T  
Dimension: 75 CM\*30 CM  
Material: ENGRAVED TRIESTA



Code: P002-T  
Dimension: 10 CM\*30 CM  
Material: TRIESTA HONED



Wallpanel-2-YB



Code: P-001Y  
Dimension: 4 CM\*30 CM  
Material: GOLDEN SIENA HONED



Code: WP-2-Y  
Dimension: 75 CM\*30 CM  
Material: GOLDEN SIENA AND THE ENGRAVING IS COLORED WITH BLUE



Code: P-002Y  
Dimension: 10 CM\*30 CM  
Material: GOLDEN SIENA HONED



# Mosaics

# Engraved Borders

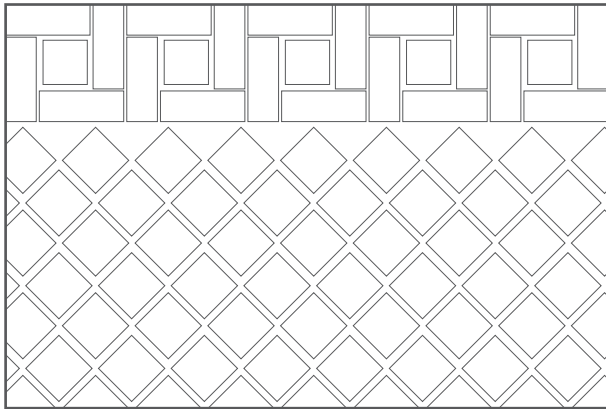

## Finishes

P  
T

Polished  
Tumbled



Code: B12E015  
Dimension: 8.5\*27



Code: B2E-017T  
Dimension: 10.5\*36



Code: TERRA  
Dimension: 10\*30



Code: B-009KG  
Dimension: 10\*30.5



Code: B2E-017G  
Dimension: 10.5\*36



Code: CALISTO  
Dimension: 10\*30



Code: TERRA-C  
Dimension: 10\*10



Code: B001EC-TG  
Dimension: 12\*28.5



Code: CALISTO-C  
Dimension: 10\*10

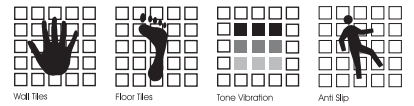

# Mosaics

# Borders

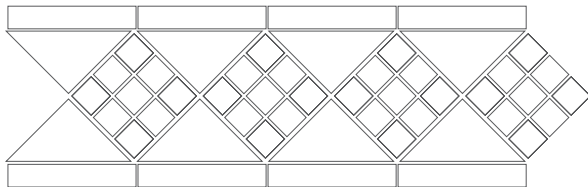
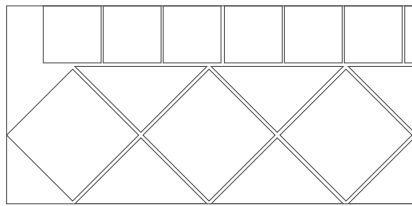

## Finishes

- P Polished
- T Tumbled
- H Honed



Code: B-001GT  
Dimension: 12\*28.5



Code: B-002GT  
Dimension: 10.5\*28.5



Code: B-001OT  
Dimension: 12\*28.5



Code: B-001GT  
Dimension: 12\*28.5



Code: B-002MG  
Dimension: 10.5\*28.5



Code: B-001YG  
Dimension: 12\*28.5



Code: B-002YG  
Dimension: 10.5\*28.5



Code: B-002MY  
Dimension: 10.5\*28.5

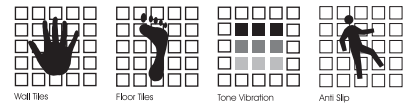

# Mosaics

# Borders

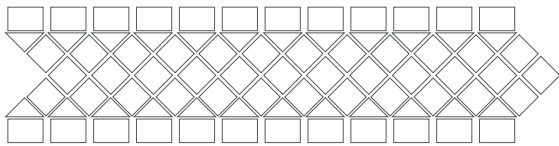
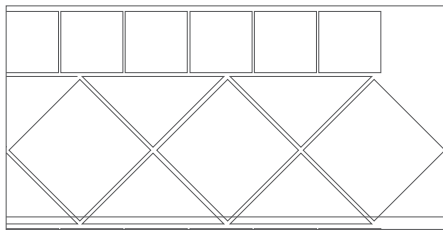

## Finishes

- P Polished
- T Tumbled
- H Honed



Code: B-004MY  
Dimension: 10.5\*28.5



Code: B-004OG  
Dimension: 10.5\*34



Code: B-004OYG  
Dimension: 10.5\*34



Code: B-004GT  
Dimension: 10.5\*28.5



Code: B-004YG  
Dimension: 10.5\*28.5

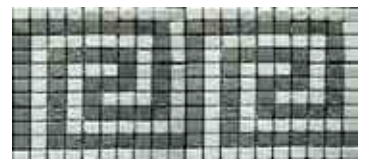

Code: B00V-GM  
Dimension: 18.5\*34



Code: B-004MG  
Dimension: 10.5\*28.5

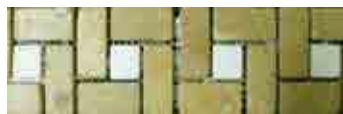

Code: B-007YG  
Dimension: 7.5\*30.5

# Finishing Methods



Bush Hammer



Acid Wash



Honed



Polished



Poly Brushed



Sand Blasted



Broken Edge



Sandblasted



Splitting mountain Face



Flamed



Split Liner



Chamfered edge



Round Edge



Pool Nose



Brushed and Chiseled Edge



Tumble



Granite

# Installation Ideas

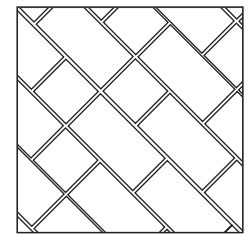
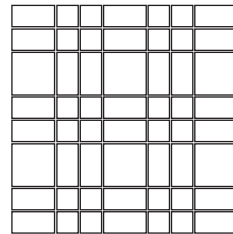
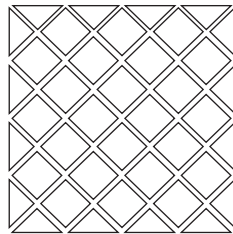
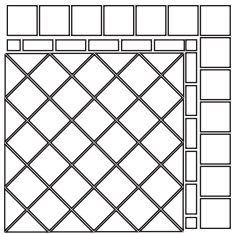
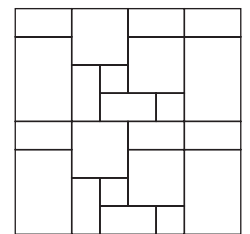
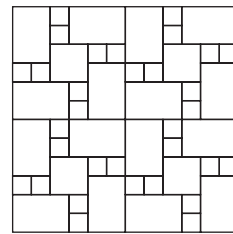
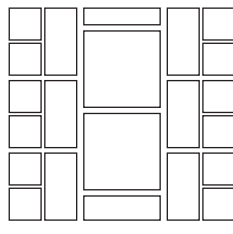
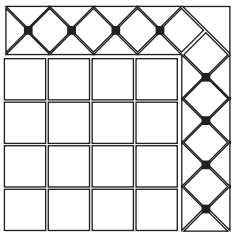
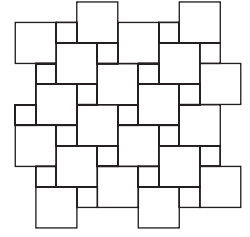
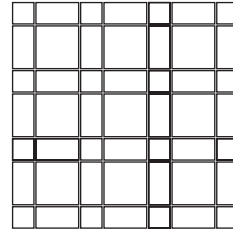
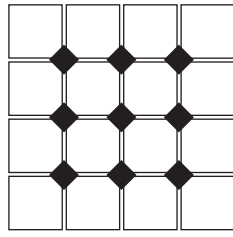
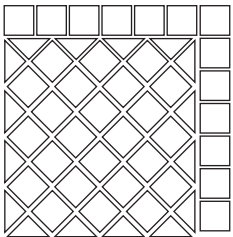
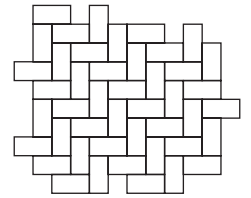
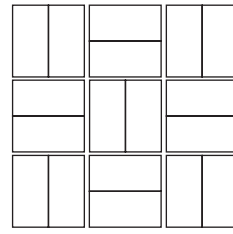
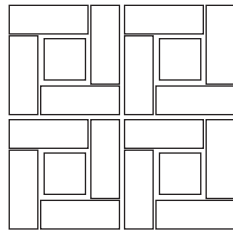
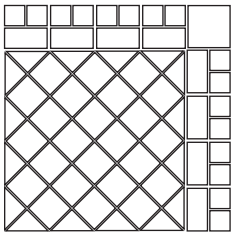



# Projects



# Projects



# Projects



# Projects

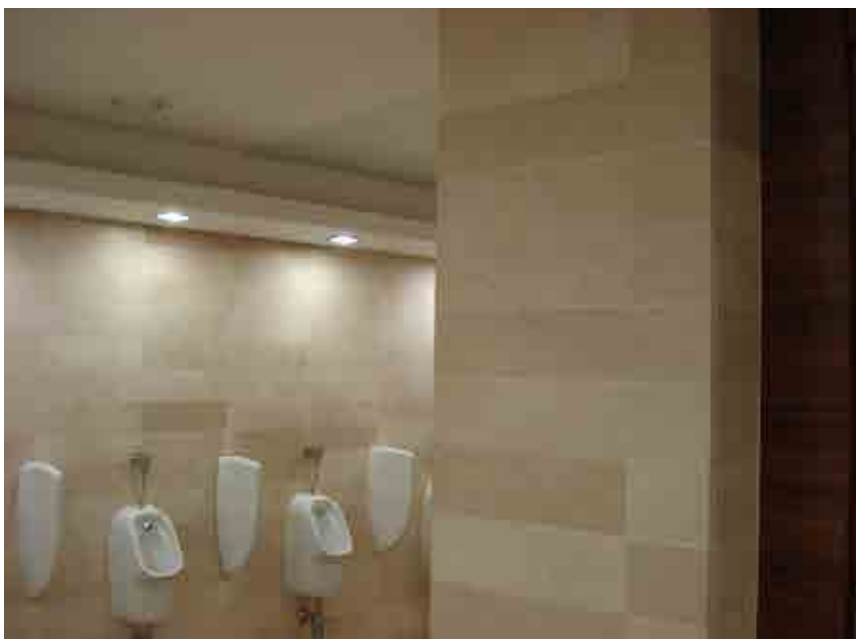



# Packing & Export



Shipped to Libya



Slabs Packing



Slabs Packing



Slabs Packing



# Packing & Export

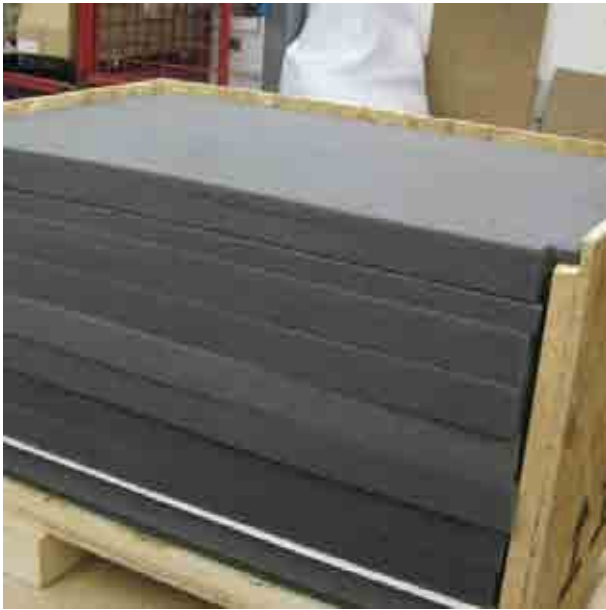

Slabs Shipping



Packing



Wooden Boxes

# Packing & Export



Tiles Packing



Slabs Packing



Packing



Tiles Packing

# Packing & Export



1cm Thickness Packing



Tiles Packing



Slabs Packing



Tiles Packing

It's a great pride for us to contact your gorgeous Firm's staff. Adam Stones Co is a leading Supplier & distributor of the finest Marble patterns all over the world. Our products are characterized by their High Quality; they are processed using high technology.

Our marble products cover tiles, slabs and all sizes as well as the styles are available for your customized design. As for finishes, we face no trouble in meeting your decorative requirements such as Unpolished, Polished, Honed, Bush Hummerd, flamed, Antique Acide, Brushed and others.

Customer's satisfaction is our motto; Adam Stone's staff is able to supply you with your needs before delivery time.

We look forward to providing you with your touch of elegance with Egyptian Marble & Granite.



**ADAM STONE**  
The Natural Stone Company

98 Al-Aml Building  
Autosturad Road - Maadi - Egypt

Tel./Fax: +2 02 2700 64 95  
Mobile: +2 011111 05 446

Email: [info@adamstones.com](mailto:info@adamstones.com)